

# G 121 Y

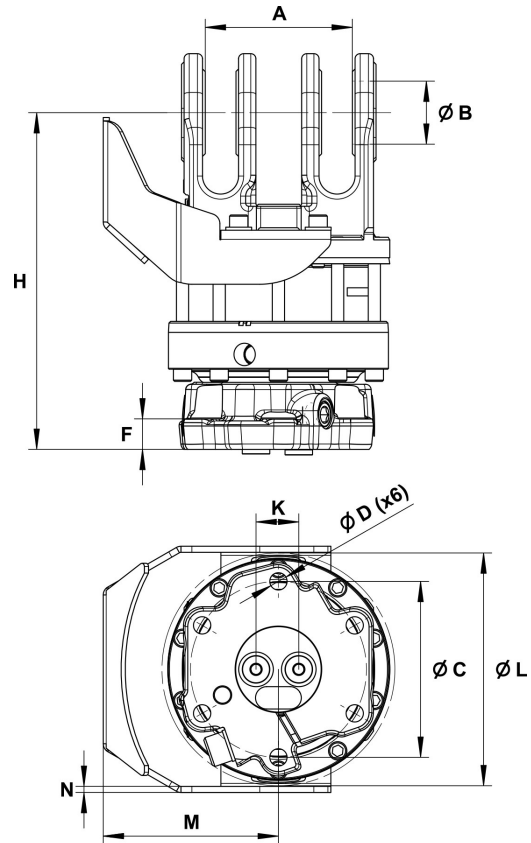

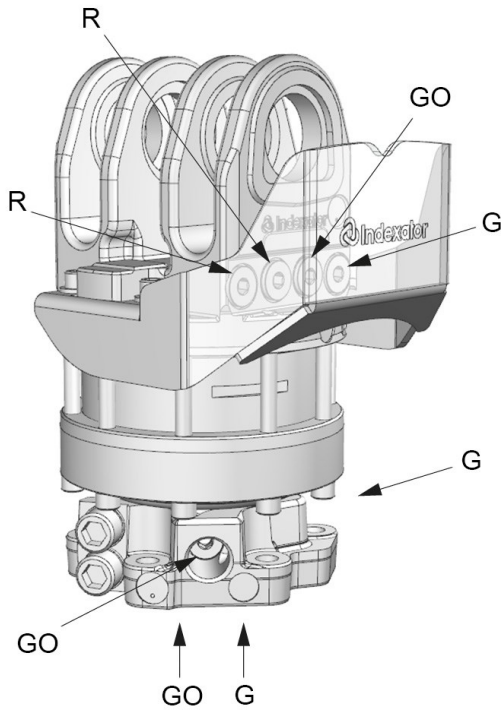





Part No.: 7212052

- Protected Hose Routing



Upper connection	Lower connection
G 1/2	G 1/2

A: MPB1	B: MPB	C: Ø173 mm	D: Ø17 mm	F: 30 mm	H: 333 mm	K: 43 mm	L: Ø229 mm	M: 164 mm	N: 6 mm
------------	-----------	---------------	--------------	-------------	--------------	-------------	---------------	--------------	------------

								
57.2 kg	360°	Max 100 kN	Max 50 kN	2200 Nm	Max 25 l/min	Max 25 MPa	Max 25 MPa	Max 25 MPa

Rotator suitable for MPB swing dampers.

Adapter sets are available for alternative connections.

For further technical information relating to integration and hydraulic connections, please contact [rotator@indexator.com](mailto:rotator@indexator.com)